

LV - LOUVRES
63 SERIES

PROFILE NO.	PICTURE OF PROFILE	WEIGHT (KG/M) / AREA PERIMETER			PACKING IN BUNDLE (PCS)	
			B 0.90 MM Thk.	H 1.20 MM Thk.		J 1.30 MM Thk.
LV 6301		-	-	-	0.592 320.898	6
LV 6302		0.80 MM Thk. 0.138 111.756	-	-	0.224 113.327	20
LV 6303		E 1.05 MM Thk. 0.510 349.384	-	-	0.620 348.684	5
LV 6304		-	-	-	0.458 262.642	6
LV 6305		-	-	0.609 344.973	-	5
LV 6306		F 1.10 MM Thk. 0.208 129.859	-	-	-	10
LV 6307		-	0.244 190.908	-	0.348 187.600	10
LV 6309		-	0.169 124.427	-	-	20
LV 6313		-	-	0.824 220.286	-	3
LV 6315		1.00 MM Thk. 0.218 146.513	-	-	-	10
LV 6318		1.00 MM Thk. 0.490 348.864	-	-	-	-
LV 6322		1.00 MM Thk. 0.408 275.37	-	-	-	10
LV 6323		1.10 MM Thk. 0.204 134.31	-	-	-	20

All Profiles are standard length 6.1 M for LV Series

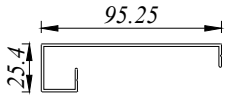
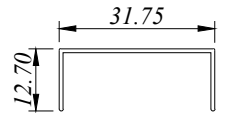
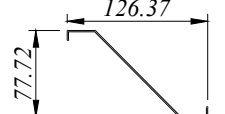
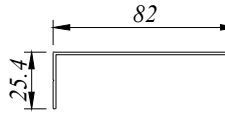
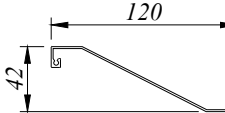
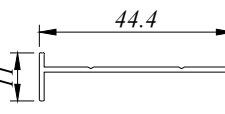
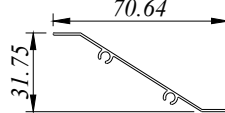
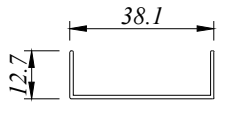
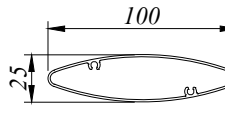
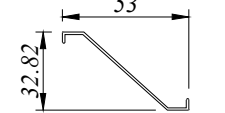
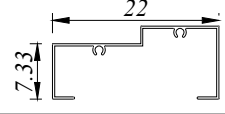
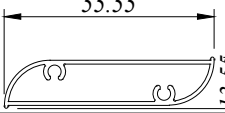
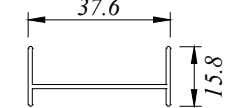
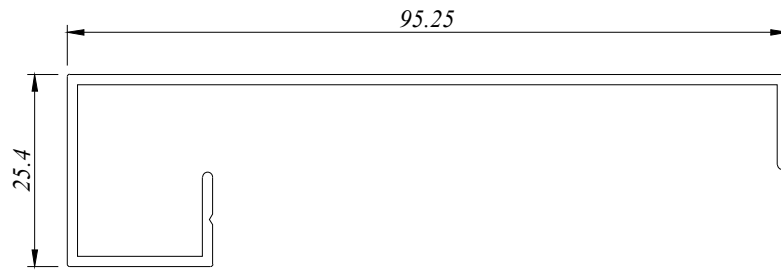

LV 6301 J
0.592 Kg/M
AP : 320.898 MM

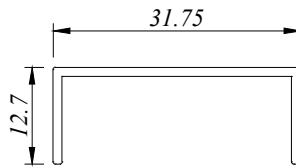

LV 6302
0.138 Kg/M
AP : 111.756 MM

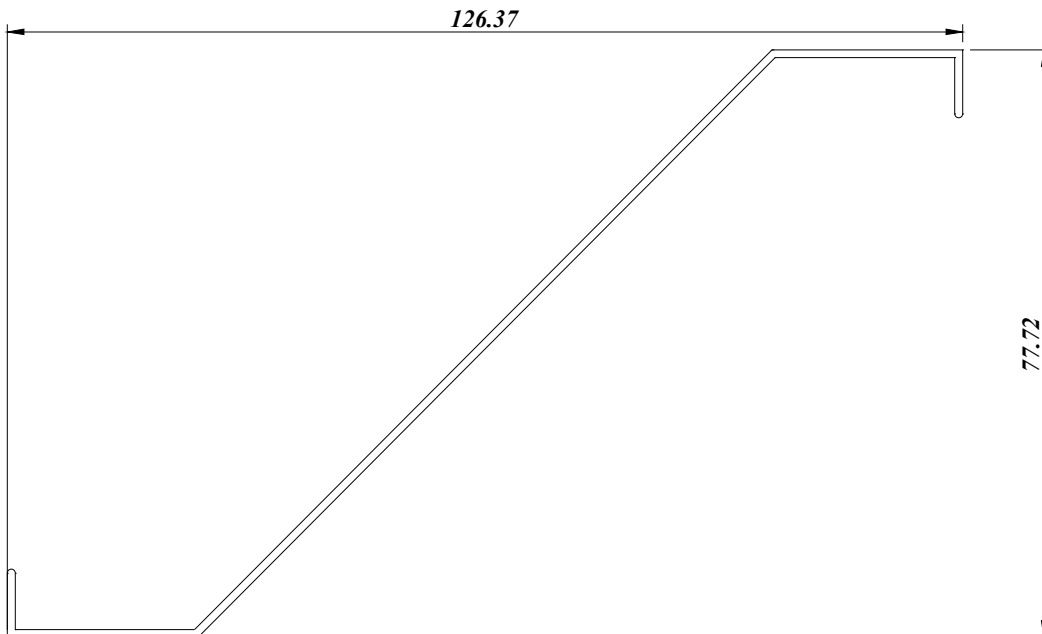

LV 6303 J
0.620 Kg/M
AP : 348.684 MM

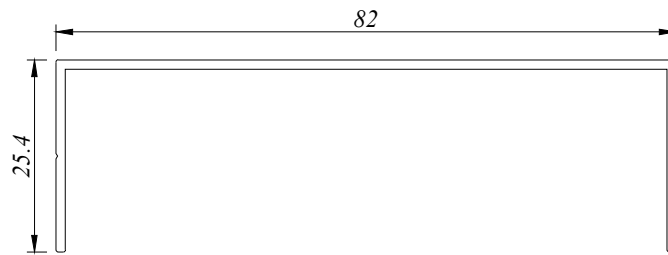

LV 6304 J
0.458 Kg/M
AP : 262.642 MM

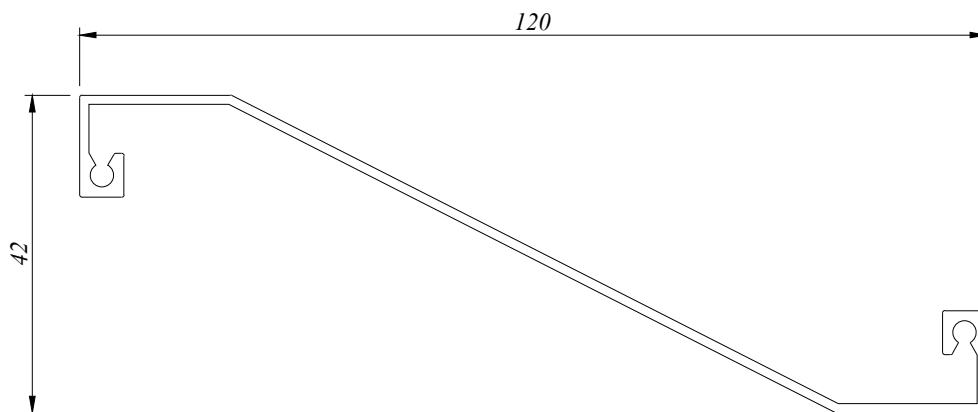

LV 6305 H
0.609 Kg/M
AP : 344.973 MM

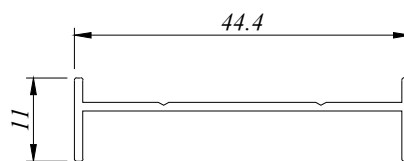

LV 6306 F
0.208 Kg/M
AP : 129.859 MM

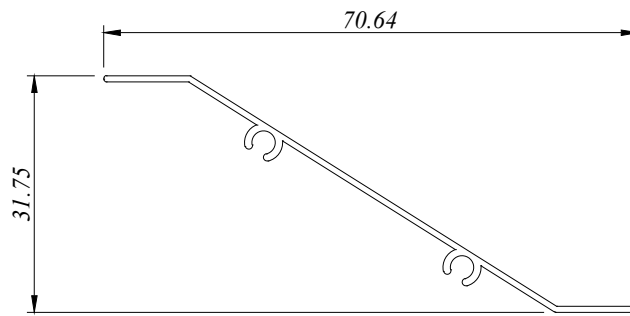

LV 6307 B
0.244 Kg/M
AP : 190.908 MM

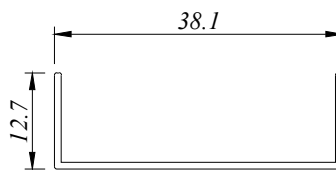

LV 6309 B
0.169 Kg/M
AP : 124.427 MM

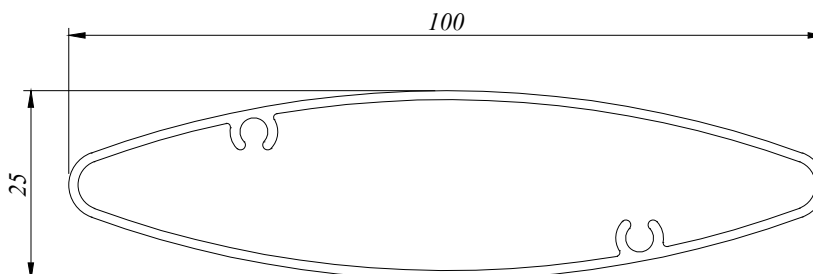

LV 6313 H
0.824 Kg/M
AP : 220.286 MM

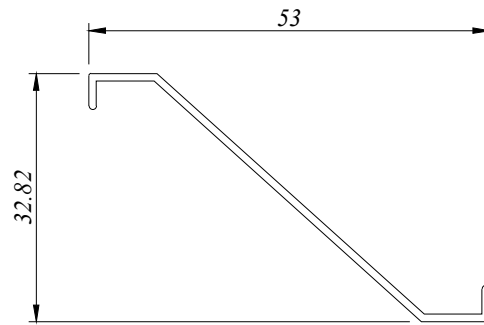

LV 6315
0.218 Kg/M
AP : 146.513 MM

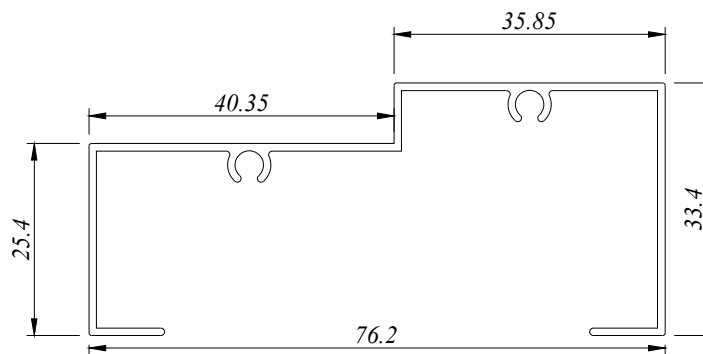

LV 6318
0.490 Kg/M
AP : 348.864 MM

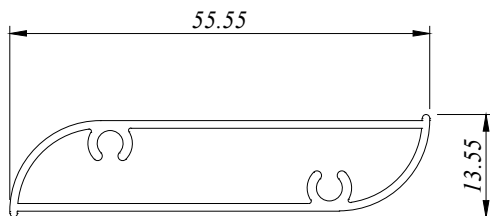

LV 6322
0.408 Kg/M
AP : 275.37 MM

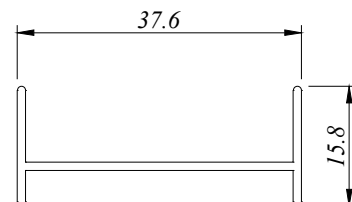

LV 6323
0.204 Kg/M
AP : 134.31 MM

aluminium profiles component usage

LOUVRES - LV 63 Series

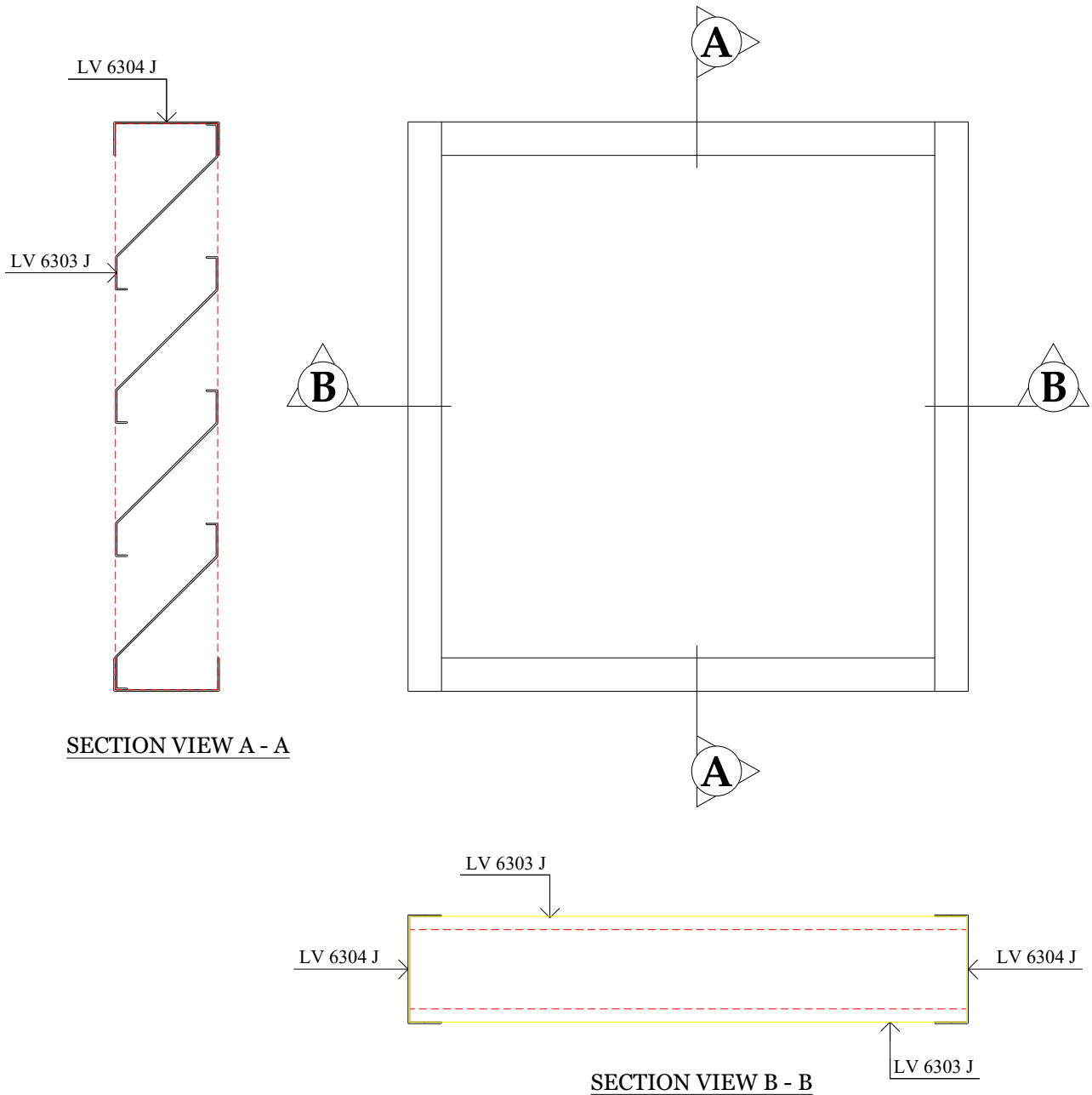

we made aluminium into shapes ...

profile information

aluminium profiles component usage

LOUVRES - LV 63 Series

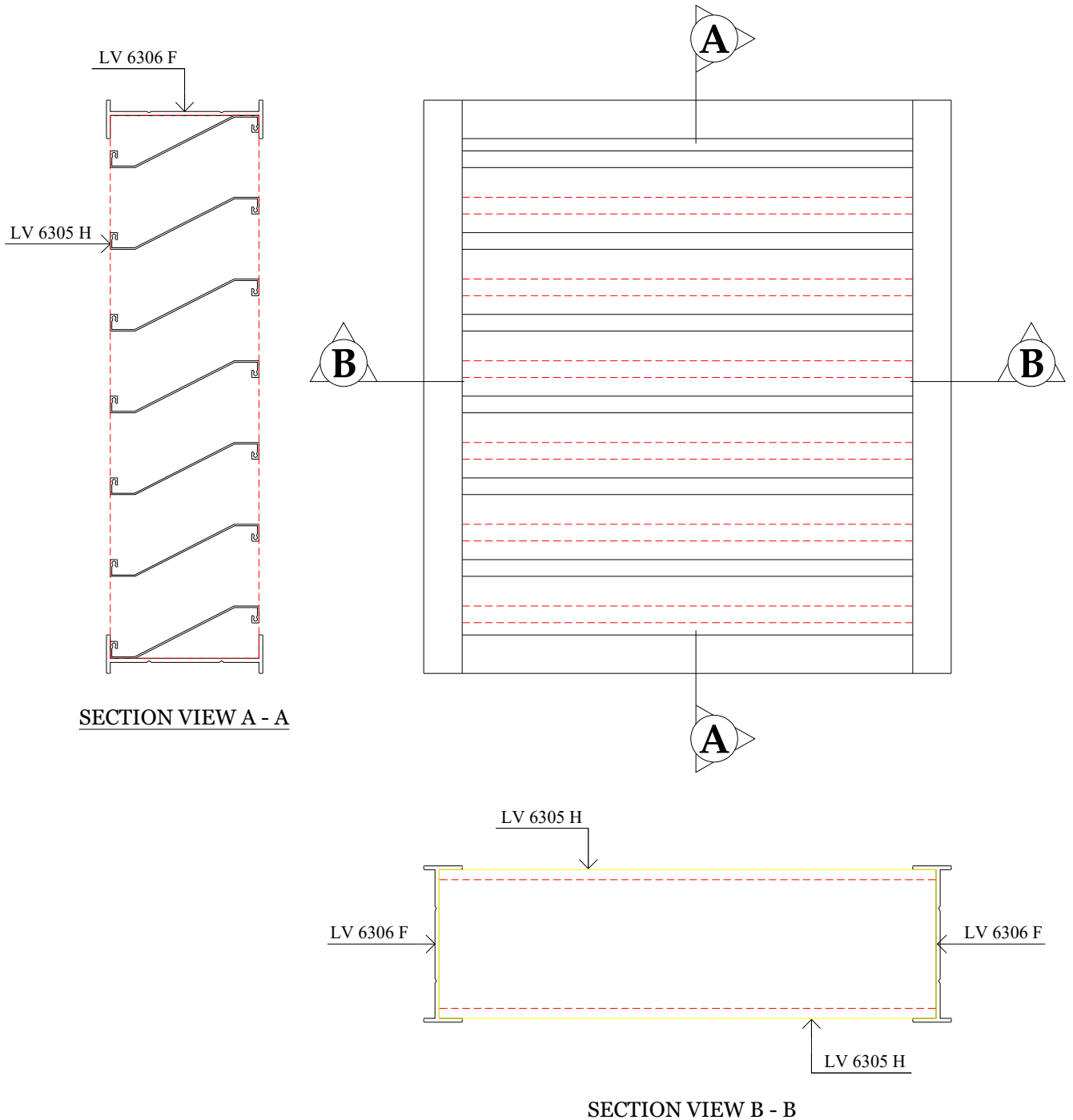

we made aluminium into shapes ...

profile information

aluminium profiles component usage

LOUVRES - LV 63 Series

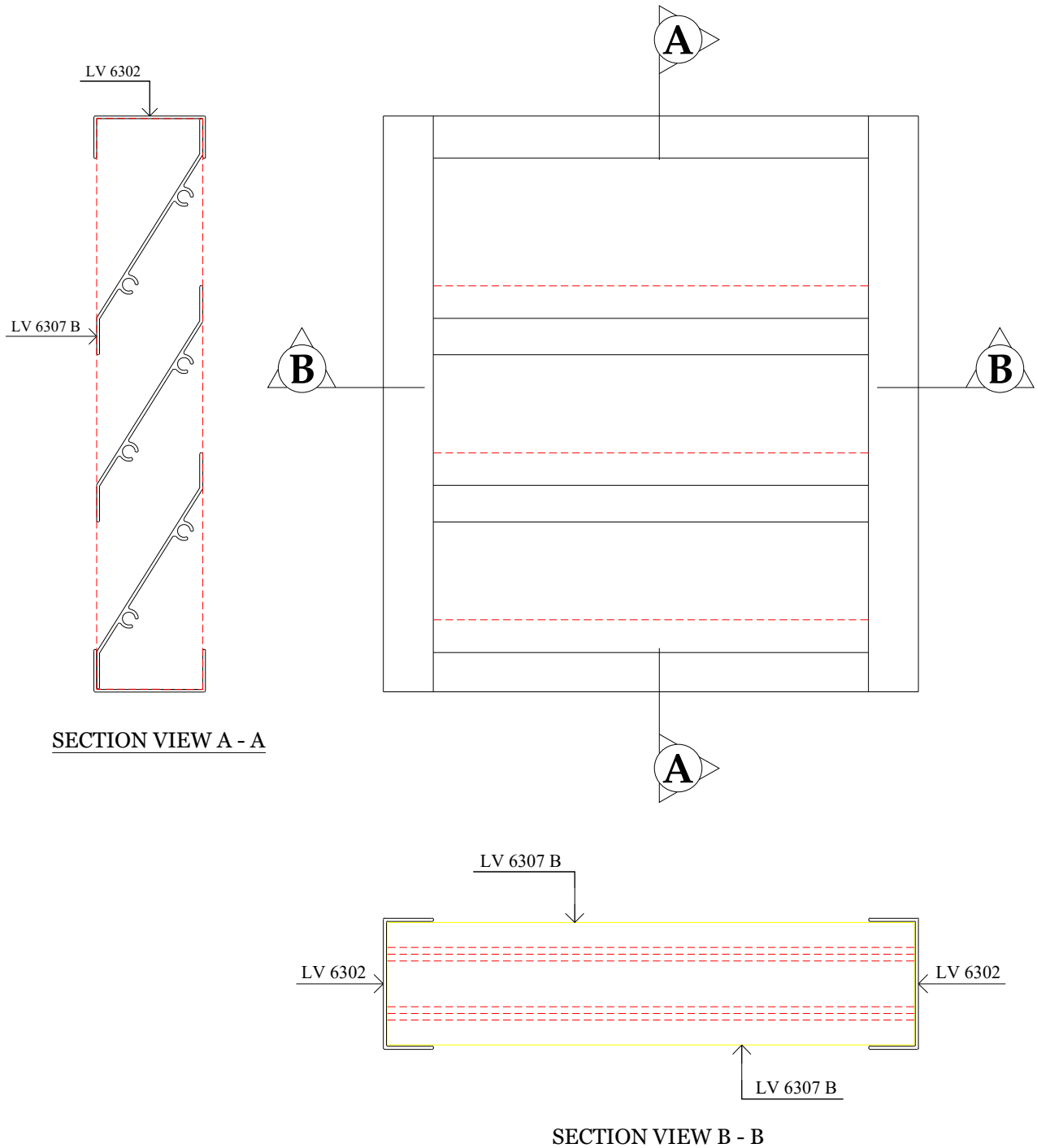

we made aluminium into shapes ...

profile information

aluminium profiles component usage

LOUVRES - LV 63 Series

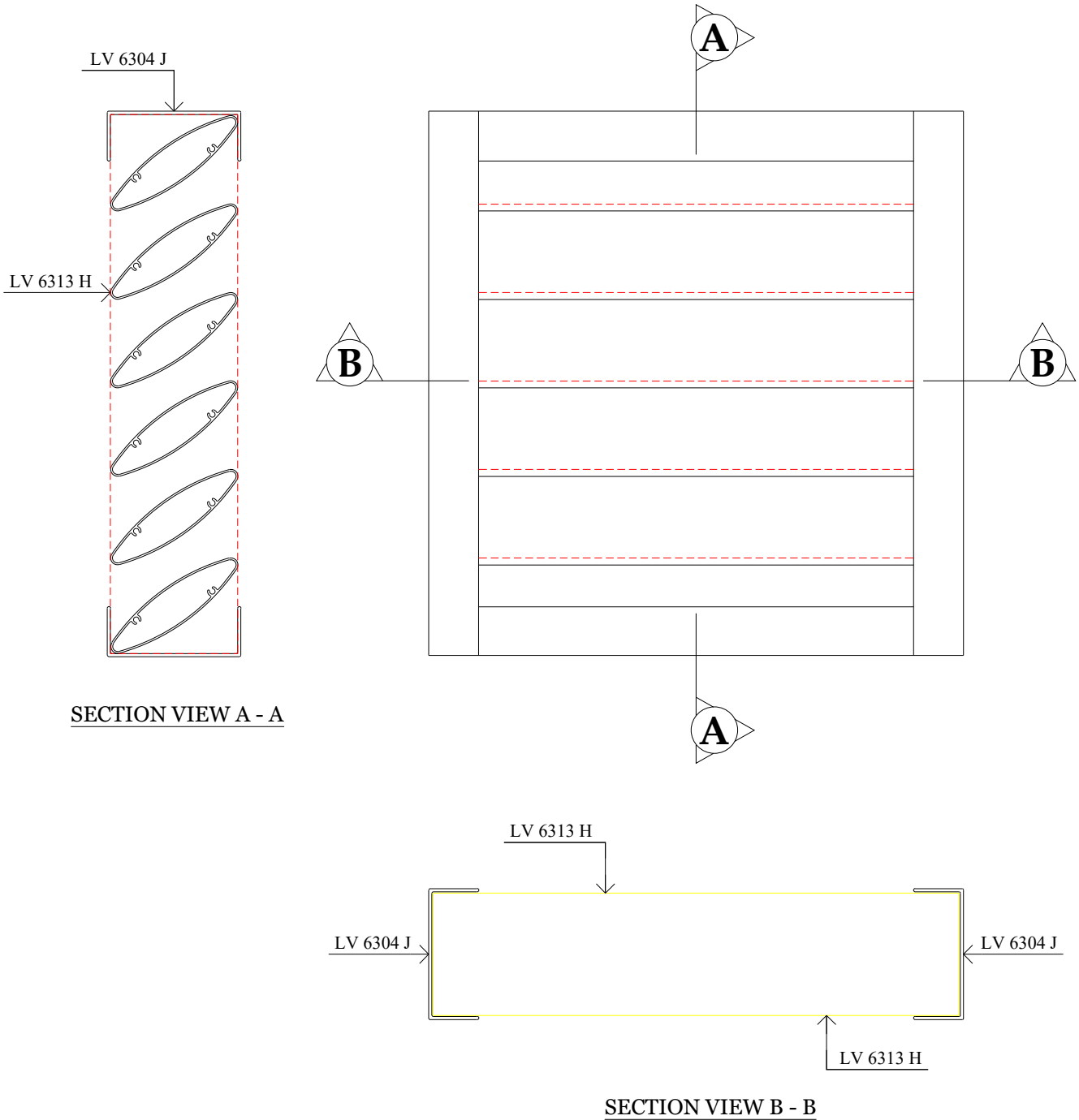

we made aluminium into shapes ...

profile information

aluminium profiles component usage

LOUVRES - LV 63 Series

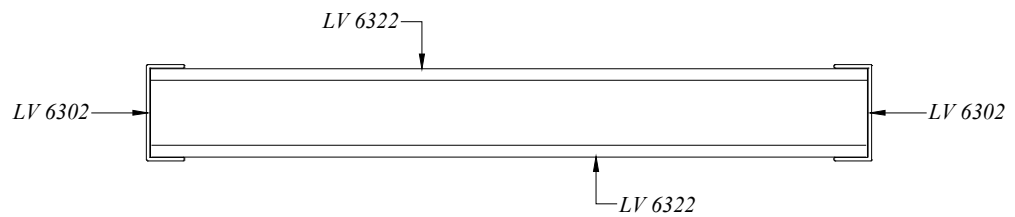
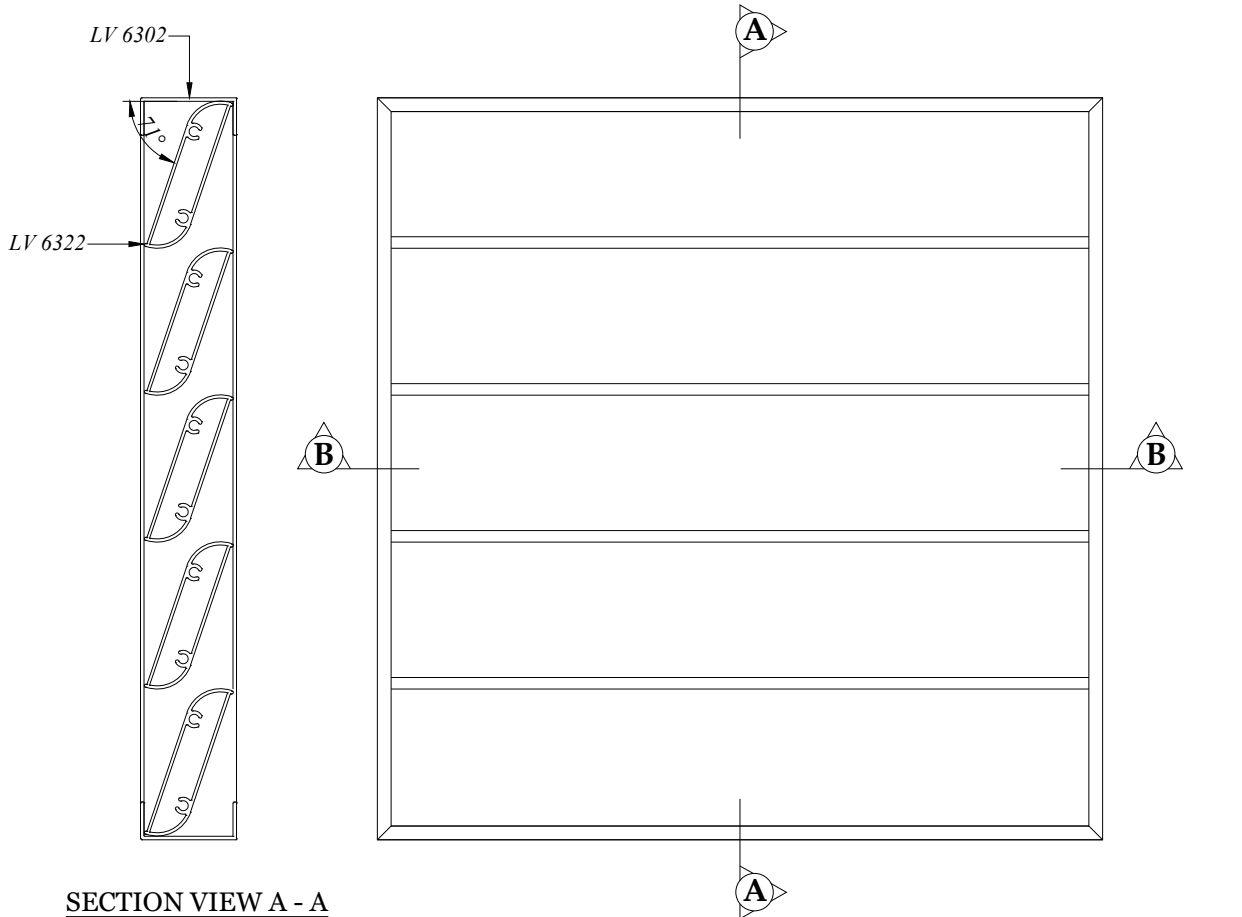

SECTION VIEW B - B

aluminium profiles component usage

LOUVRES - LV 63 Series

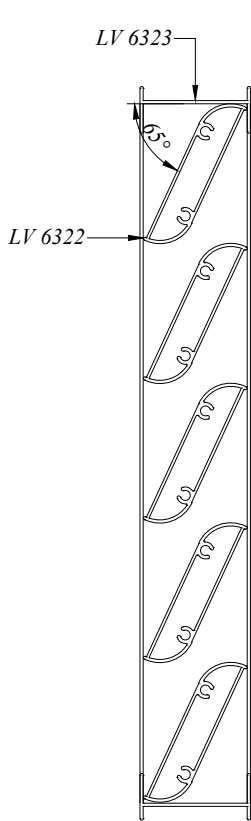

SECTION VIEW A - A

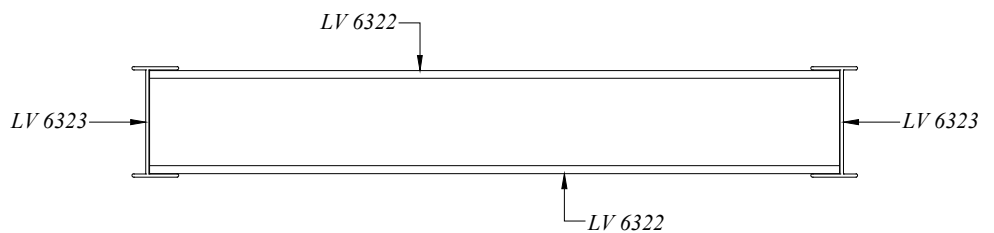
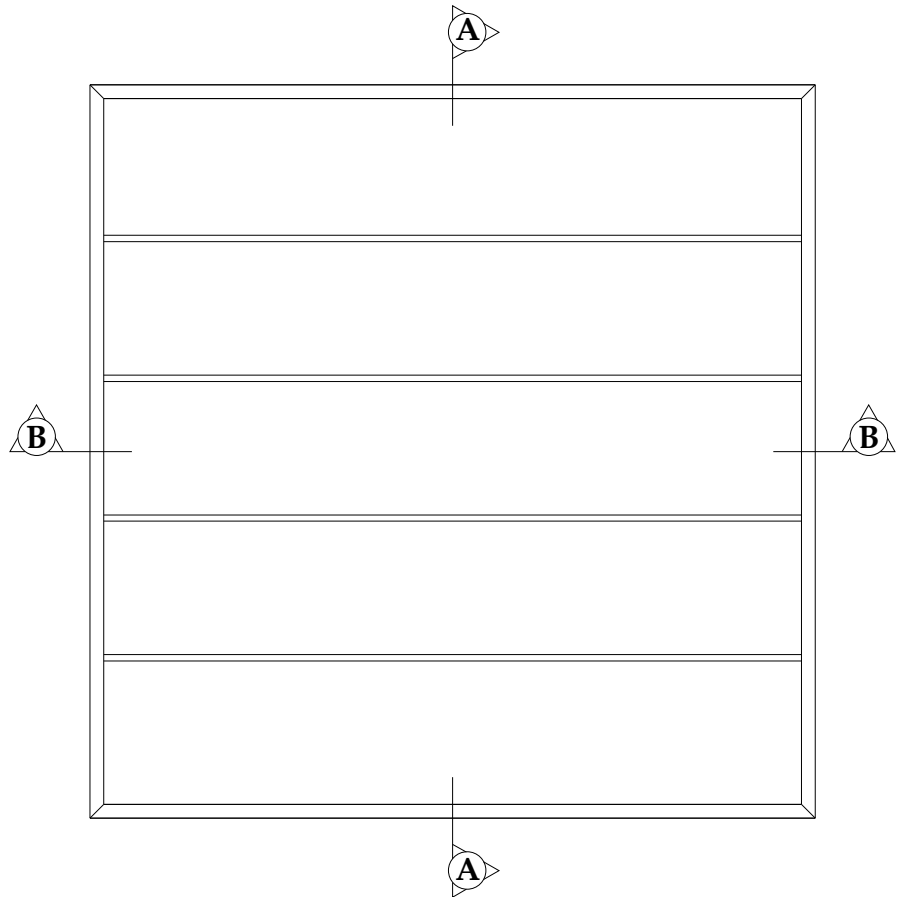

SECTION VIEW B - B

we made aluminium into shapes ...

profile information

aluminium profiles component usage

LOUVRES - LV 63 Series

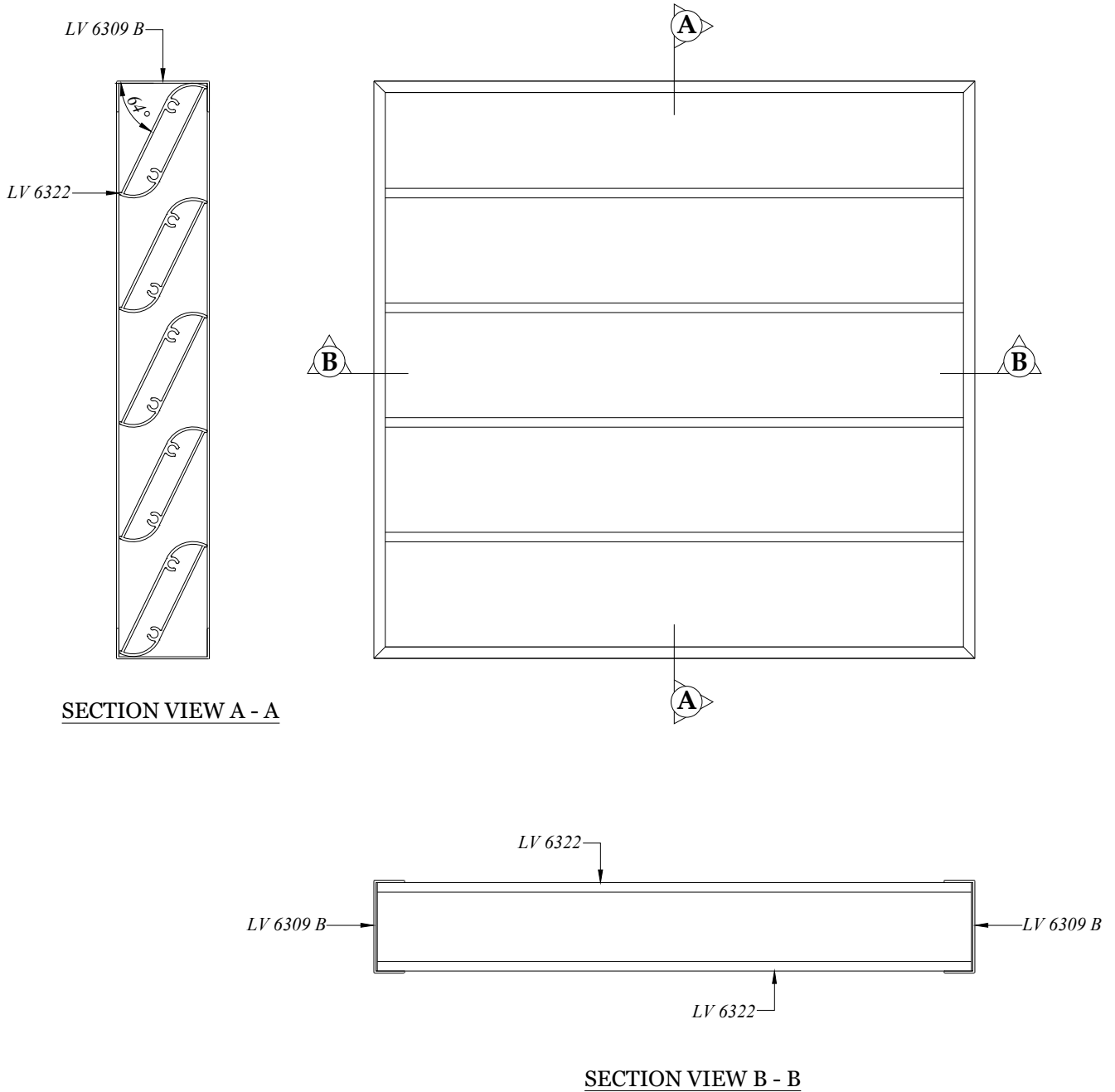

we made aluminium into shapes ...

profile information

aluminium profiles component usage

LOUVRES - LV 63 Series

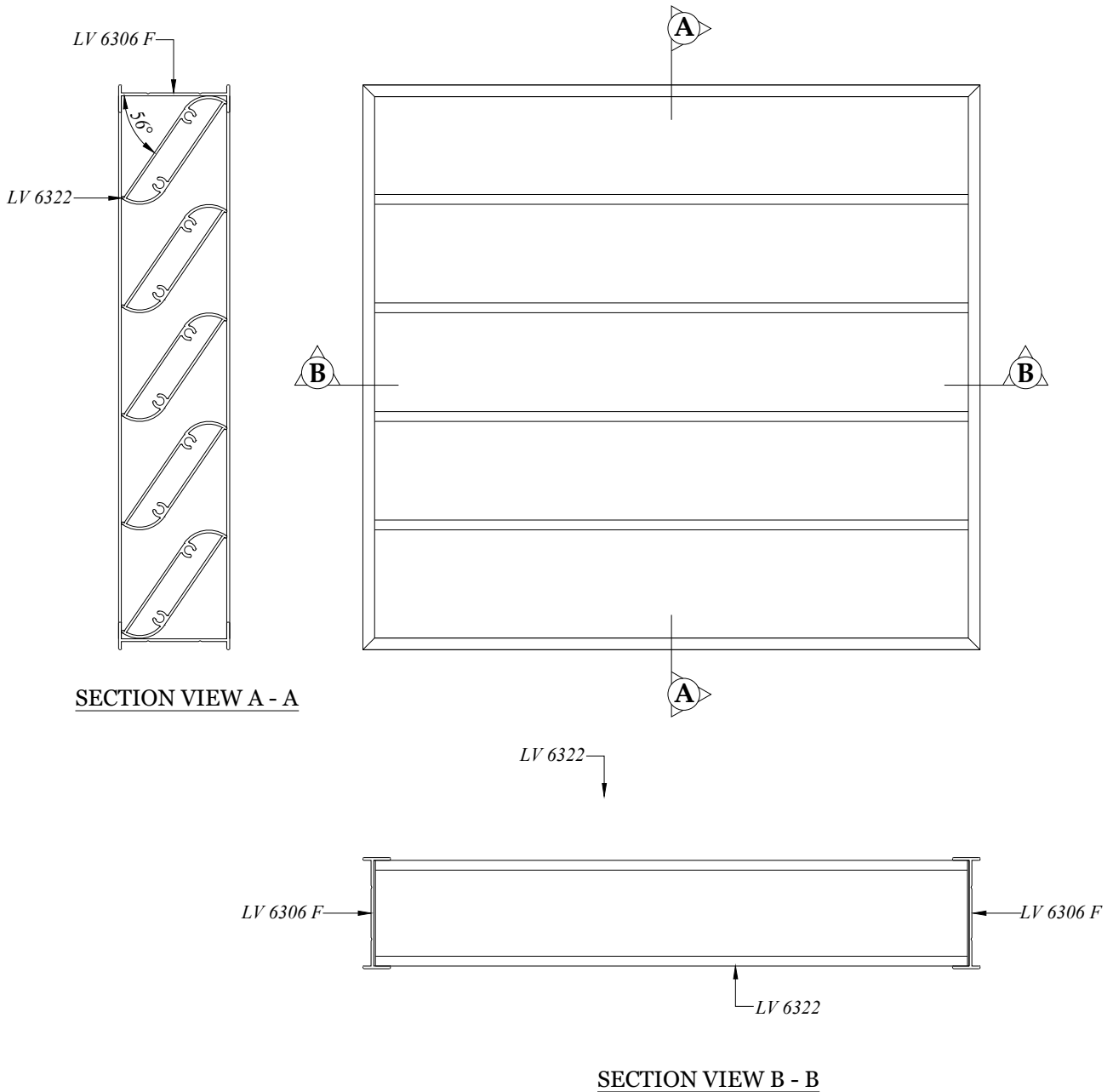

aluminium profiles component usage

LOUVRES - LV 63 Series

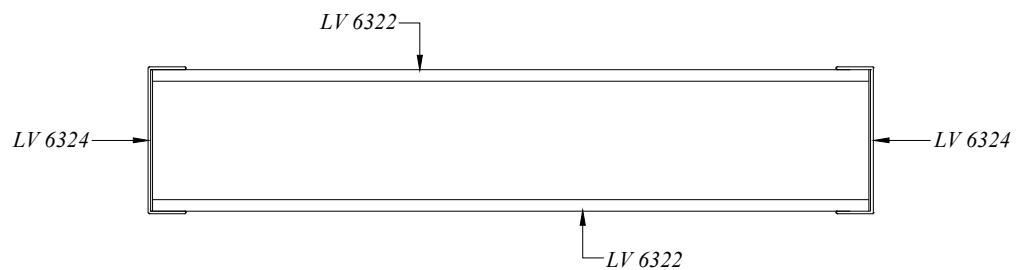
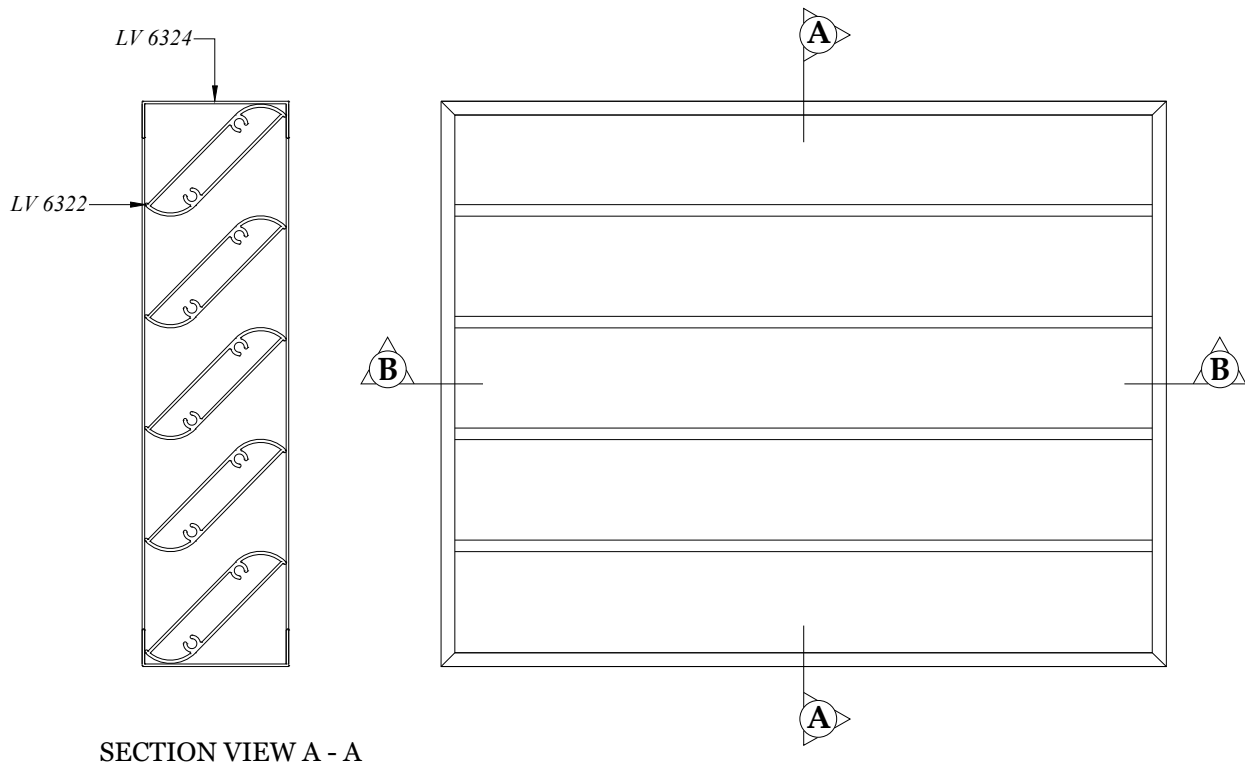

BP Aluminium Extrusion Sdn. Bhd.

No.15 & 16, 1C KKIP Selatan, Industrial Zone 2, KKIP,
88450, Jalan Sepanggar, Menggatal.

t : 60-88-499333, 499111 f : 60-88-499222

b_p_a_e@yahoo.com